

Pre-owned Car Certificate

Mercedes-Benz vehicle are checked comply to
Mercedes-Benz Thailand requirements



VIN: W1N2477876L011531
Inspection Report No.: 141
Inspection Date: 13/12/2024
KM Status: 28338

Grading Level

- | | | | |
|----|---|---|-------------------------------------|
| 3A | = | Excellent Condition (No repaint or parts damage) | <input type="checkbox"/> |
| A | = | Good Condition (a parts re-painted or slightly damage) | <input checked="" type="checkbox"/> |
| B | = | Normal Condition (several parts repainted or slightly damage) | <input type="checkbox"/> |
| C | = | Poor Condition (medium/heavy accident, no or poor rework) | <input type="checkbox"/> |

Patananda 17 DEC 2024

Signature / Date

On behalf of **BGAC MB Automotive Engineering**

VIN: W1N2477876L011531
Inspection Report No.: 141
Inspection Date: 13/12/2024
KM Status: 28338

Photo documentation - Exterior



Front Right View

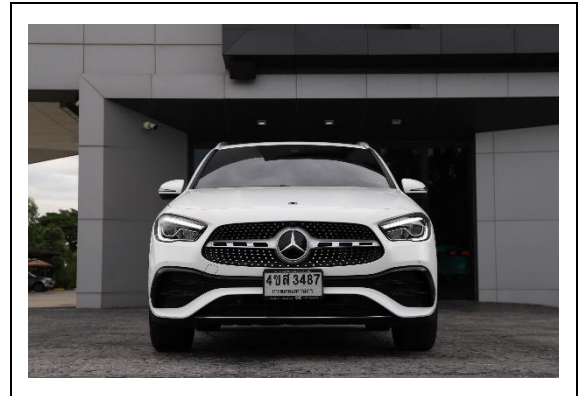

Front View



Front Left Side View



Front Right Side View



Rear Left Side View



Rear View

VIN: W1N2477876L011531
Inspection Report No.: 141
Inspection Date: 13/12/2024
KM Status: 28338

Photo documentation - Interior

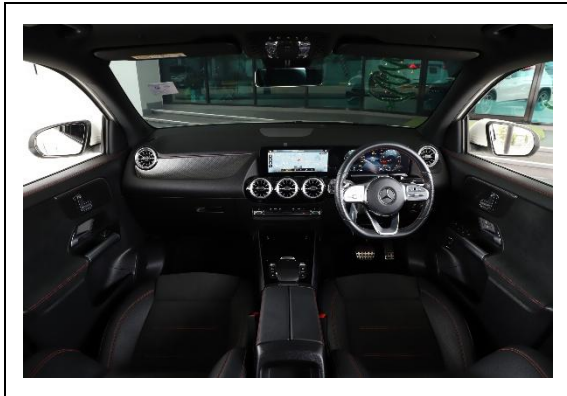

Cockpit

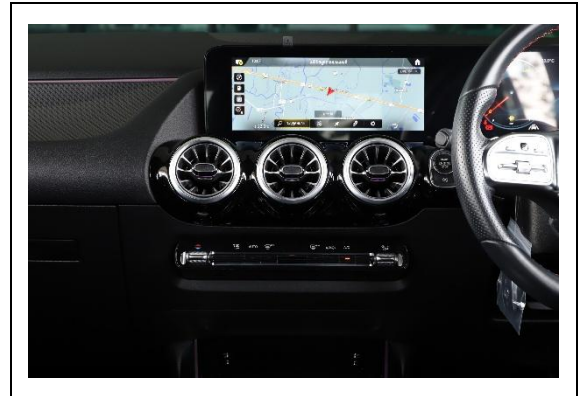

Media Display



Instrument Cluster



Center Console

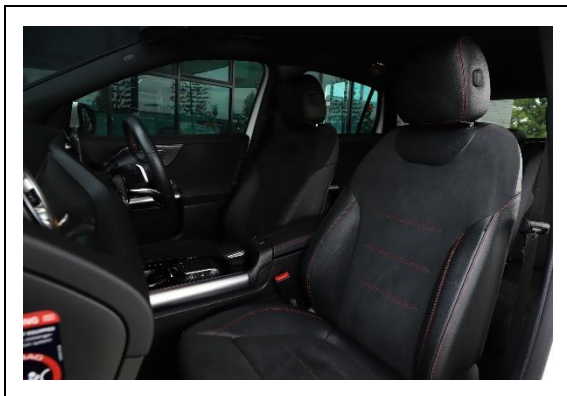

Front Entrance

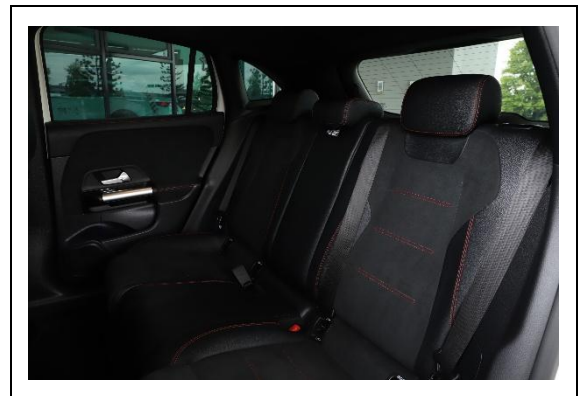

Rear Entrance

VIN: W1N2477876L011531
Inspection Report No.: 141
Inspection Date: 13/12/2024
KM Status: 28338

Photo documentation - Engine / Aggregates

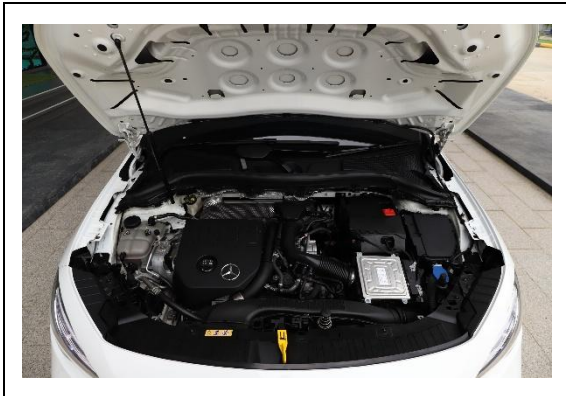

Engine



Underbody



Front Left / Right Axle

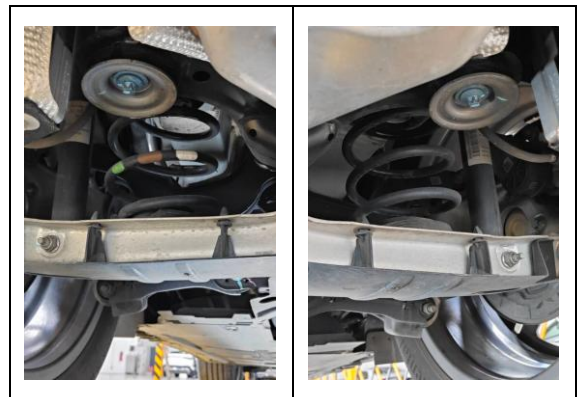

Rear Left / Right Axle

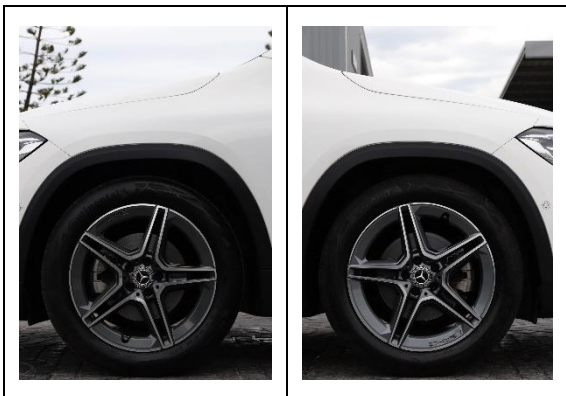

Front Left / Right Wheel



Rear Left / Right Wheel

VIN: W1N2477876L011531
Inspection Report No.: 141
Inspection Date: 13/12/2024
KM Status: 28338

Scope of visual check based on MBTh requirements

A. Scope of visual inspection

Visual check of accident / flooding damage / impact on body, paint surface and underbody parts:

- | | |
|------------------------------------|-------------------------------------|
| N = No damage | <input type="checkbox"/> |
| S = Minor damage | <input checked="" type="checkbox"/> |
| M = Medium damage | <input type="checkbox"/> |
| L = Large / heavy damage or impact | <input type="checkbox"/> |
| X = Extra damage or impact | <input type="checkbox"/> |

Damage areas

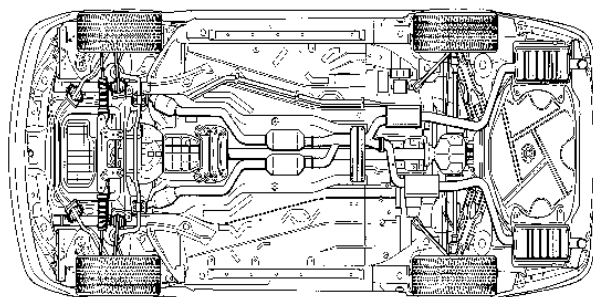
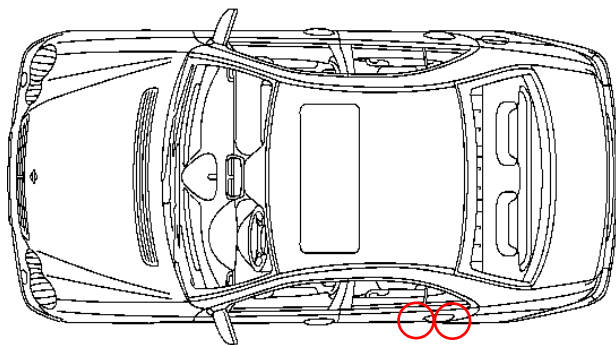

B. Summarize condition statement

- Front Left Door - Light Scratch
- Front Left Door Handle - Paint Chip

VIN: W1N2477876L011531
Inspection Report No.: 141
Inspection Date: 13/12/2024
KM Status: 28338

Photo documentation - Non-Conformities (if any)

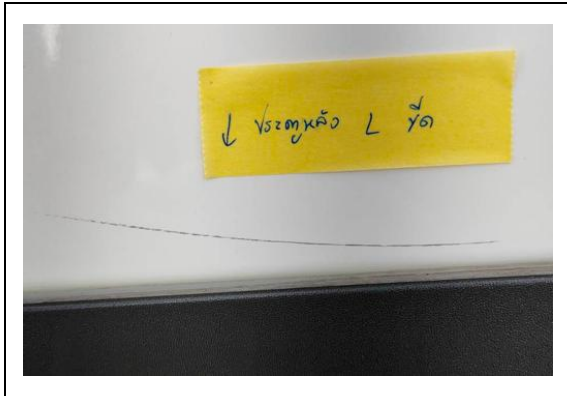

Front Left Door - Light Scratch

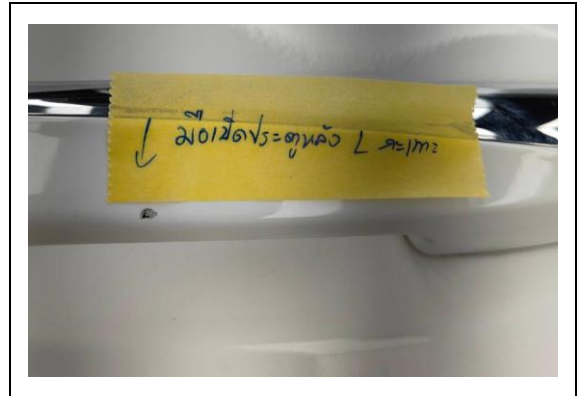

Front Left Door Handle - Paint Chip

